

Aqualyze Economic Plastic Filter Housing

10" and 20" in Regular and Large Diameter

The most recent addition to the SPECTRUM housing portfolio is the Aqualyze Economic plastic range. Having taken key features from the marketplace and improved them accordingly, these housings meet the needs of economy, quality and ease-of-use. This latest range rivals higher priced competitors in the industry without compromising materials or calibre. Evident in the housings approvals and test criteria, their flexible configurations using brackets and adaptors encourages easy-to-build systems. Housings come in either opaque or clear options with ¼" to 1" ports and lengths of 10" and 20".

Pressure Release Valve (PRV)

The first full-fit pressure release valve with hexagonal fit, prevents potential weeping from accidental unwinding and aids changeout.

Centering Plug

Incorporated within the head of 20" and Large Diameter options. Unlike traditional housings, this unique centering plug prevents bypass by locating the cartridge securely whilst the open area allows for full flow.

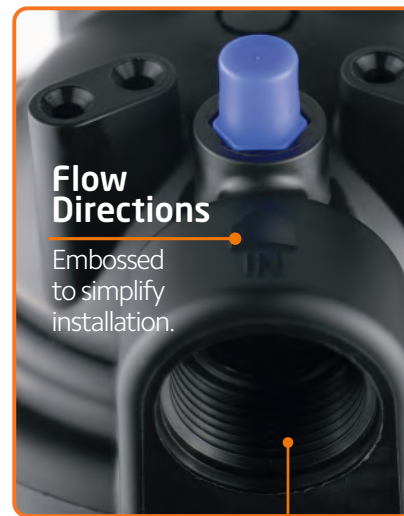

Flow Directions

Embossed to simplify installation.

Port Options

Housings come with a variety of port options from ¼" to 1" suiting standard pipework or specific application connections.

Index Thread

Easy spin-off, spin-on sumps that return to same position every time. Perfect for service and installation labelling.

Materials

Constructed using modern manufacturing techniques, without the need for talc or other chemicals, these housings are light and ergonomic whilst remaining robust. 100% virgin materials ensure broad chemical compatibility which are suitable for a range of applications.

Quick Changeout

Spanners have been designed for easy removal of the sump.



Cartridge Compatibility

Designed to enhance the filter cartridge performance across the SPECTRUM range, whilst accommodating all industry standard cartridges.



DOE

Double
Open Ended
eg. TruDepth



AA

Gasket
Ended
*eg. Media
Cartridges*



213

CG
O-ring
eg. Pleat



10 Inch

Most popular size, suited for OEM and under-sink installations.



20 Inch

Reducing changeout frequency this size housing is ideal for water treatment cartridges.



Large Diameter

Offering the highest flow rates in plastic housings at economic pricing to comparable multi-round stainless steel housings.



Plastic Filter Housing

Single Cartridge Round - Regular 10"

The most sought-after housings with four port sizes allow for different fittings and pipework. The 1/4" and 3/8" ports are typically paired with push-fit fittings and flexible tubing, ideal for OEM systems and drinking water under-sink installations. The 1/2" and 3/4" port sizes are compatible with standard inline pipe installations. Brackets and connectors allow for easy system builds.

Flow Rate (lpm)

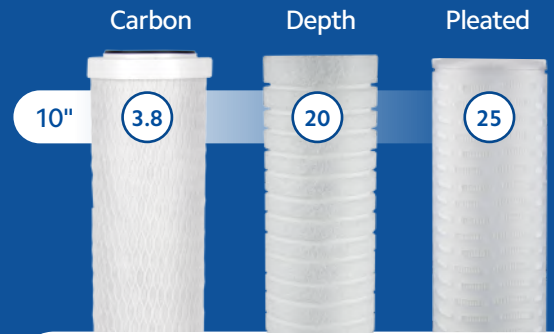

Popular and Versatile



Specification

Port Sizes (BSP")



Cartridge Compatibility (")

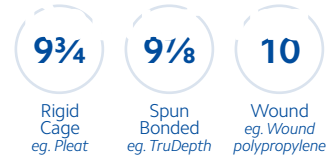

End-Cap Compatibility

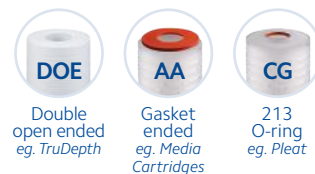

Temperature (°C)



Pressure Rating (bar)



Materials

O-ring Buna-N	PRV Polypropylene
Head Polypropylene	Spring 304 Stainless Steel
Sump - Black PK = Polypropylene	Sump - Clear SC = Styrene Acrylonitrile

SPECTRUM

FDA
Compliant Materials

PED
Compliant
Article 4, Paragraph 3
Group 2 Liquids

Code	Description	Spanner	Brackets		
			Single	Double	Triple
EFH-*-1-10-1/4	10" Economic Filter Housing No PRV - 1/4" ports	EFH-SW10	EFH-BK-1	EFH-BK-2-10	EFH-BK-3-10
EFH-*-1-10-3/8	10" Economic Filter Housing No PRV - 3/8" ports	EFH-SW10	EFH-BK-1	EFH-BK-2-10	EFH-BK-3-10
EFH-*-1-10-1/2	10" Economic Filter Housing PRV - 1/2" ports	EFH-SW10	EFH-BK-1	EFH-BK-2-10	EFH-BK-3-10
EFH-*-1-10-3/4	10" Economic Filter Housing PRV - 3/4" ports	EFH-SW10	EFH-BK-1	EFH-BK-2-10	EFH-BK-3-10

* Select PK or SC

Plastic Filter Housing

Single Cartridge Round - Regular 20"

Aiding larger flow rates than the popular 10" range, 20" housings facilitate greater cartridge capacity and extend service life. With fewer changeouts required, these housings are especially useful for water treatment cartridges. To secure the cartridge and accommodate the higher flow of a 20" filter, housings are fitted with a centering plug.

Flow Rate (lpm)

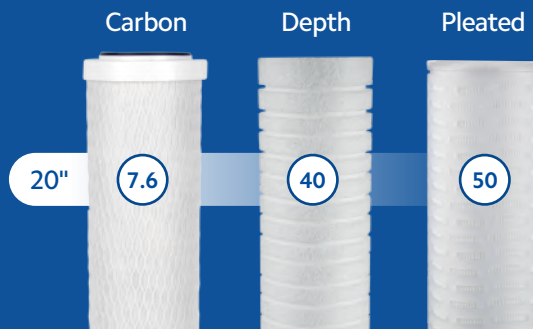

Higher Flow Rates

Colour Options



FDA
Compliant Materials

PED
Compliant
Article 4, Paragraph 3
Group 2 Liquids



Specification

Port Sizes (BSP")



Cartridge Compatibility (")



End-Cap Compatibility

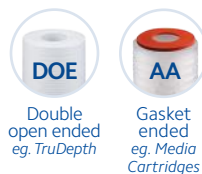

Temperature (°C)



Pressure Rating (bar)



Materials

O-ring EPDM	PRV Polypropylene
Head Polypropylene	Spring 304 Stainless Steel
Sump - Black PK = Polypropylene	Sump - Clear SC = Styrene Acrylonitrile

Code	Description	Spanner	Brackets		
			Single	Double	Triple
EFH-PK-1-20-1/2	20" Economic Filter Housing PRV - 1/2" ports	EFH-SW20	EFH-BK-1	EFH-BK-2-20	EFH-BK-3-20
EFH-PK-1-20-3/4	20" Economic Filter Housing PRV - 3/4" ports	EFH-SW20	EFH-BK-1	EFH-BK-2-20	EFH-BK-3-20
EFH-SC-1-20-1/2	20" Economic Filter Housing PRV - 1/2" ports	EFH-SW20	EFH-BK-1	EFH-BK-2-20	EFH-BK-3-20
EFH-SC-1-20-3/4	20" Economic Filter Housing PRV - 3/4" ports	EFH-SW20	EFH-BK-1	EFH-BK-2-20	EFH-BK-3-20



Plastic Filter Housing

Single Cartridge Round - Large Diameter

With the highest flow rate capacity in the plastic filter housing range, the large diameter housings compete with comparable multi-round stainless steel housings at a fraction of the cost.

Flow Rate (lpm)

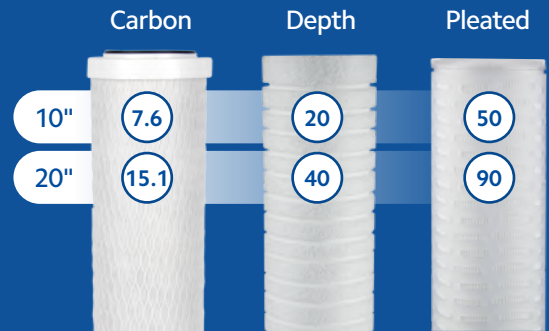

Longest Service Life



Colour Options

- PK**
Black
- SC**
Clear

FDA
Compliant Materials

PED
Compliant
Article 4, Paragraph 3
Group 2 Liquids



Specification

Port Sizes (BSP")

1

Cartridge Compatibility (")

- 9³/₄**
All Nominal LD 10" (except wound)
eg. Carbon
- 10**
Wound
eg. Wound polypropylene
- 20**
All Cartridge Types

End-Cap Compatibility

- DOE**
Double open ended
eg. TruDepth
- AA**
Gasket ended
eg. Media Cartridges

Temperature (°C)

4-40

Pressure Rating (bar)

6.9

Materials

O-ring Buna-N	PRV Polypropylene
Head PK = Polypropylene SC = Glass Filled Polypropylene	Spring 304 Stainless Steel
Sump - Black PK = Polypropylene	Sump - Clear SC = Styrene Acrylonitrile

Code	Description	Spanner	Brackets		
			Single	Double	Triple
EFH-PK-1-10LD-1	10" Economic LD Filter Housing PRV - 1" ports	EFH-SWLD	EFH-BK-LD1	EFH-BK-LD2	EFH-BK-LD3
EFH-SC-1-10LD-1	10" Economic LD Filter Housing PRV - 1" ports	EFH-SWLD	EFH-BK-LD1	EFH-BK-LD2	EFH-BK-LD3
EFH-PK-1-20LD-1	20" Economic LD Filter Housing PRV - 1" ports	EFH-SWLD	EFH-BK-LD1	EFH-BK-LD2	EFH-BK-LD3
EFH-SC-1-20LD-1	20" Economic LD Filter Housing PRV - 1" ports	EFH-SWLD	EFH-BK-LD1	EFH-BK-LD2	EFH-BK-LD3

Accessories

Housing accessories are offered to conveniently increase the ease of operation and maintenance when applied to housing installations, further improving the functionality of this SPECTRUM range of housings.



Technical Drawing

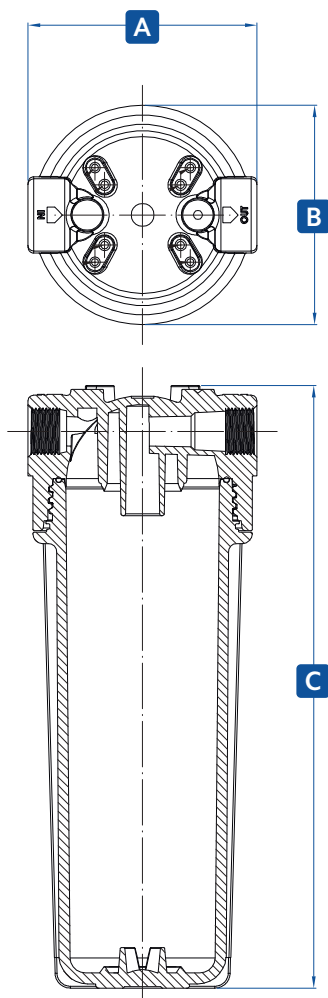

Brackets

EFH-BK

Brackets come in single, double and triple complete with wall and head mounting screws. Made from galvanized steel and coated with a white powdered finish, which prolongs the brackets life.

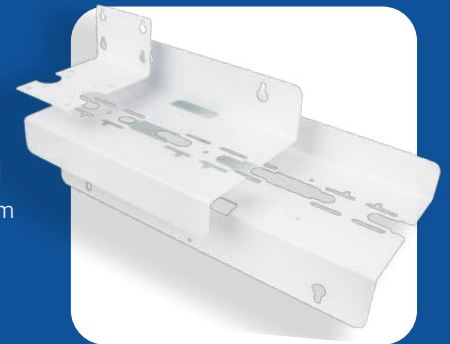

Spanners

EFH-SW

These spanners have been specifically designed to not damage the sump, which makes them invaluable for cartridge changeout.



Connectors

1/4" to 1"

To join multiple housings together or connect inlet and outlet ports to pipework, a selection of suitable fittings are available.



Dimensions (mm)

Housing	A	B	C
EFH-10" (1/4, 3/8)	120	115	318
EFH-10" (1/2, 3/4)	120	115	318
EFH-20"	134	130	582
EFH-10"LD	184	182	350
EFH-20"LD	184	182	608

Code	Description
EFH-MPF-1/4-1/4	SPECTRUM EFH 1/4" Male thread to 1/4" Push Fit
EFH-MPF-3/8-3/8	SPECTRUM EFH 3/8" Male thread to 3/8" Push Fit
EFH-MPF-1/2-1/2	SPECTRUM EFH 1/2" Male thread to 1/2" Push Fit
EFH-MPF-1/2-15MM	SPECTRUM EFH 1/2" Male thread to 15mm Push Fit
EFH-MPF-3/4-22MM	SPECTRUM EFH 3/4" Male thread to 22mm Push Fit
EFH-MCF-1-25MM	SPECTRUM EFH 1" Male thread to 25mm Compression Fit

